

VALIGIE STARC · ART. SWL/80

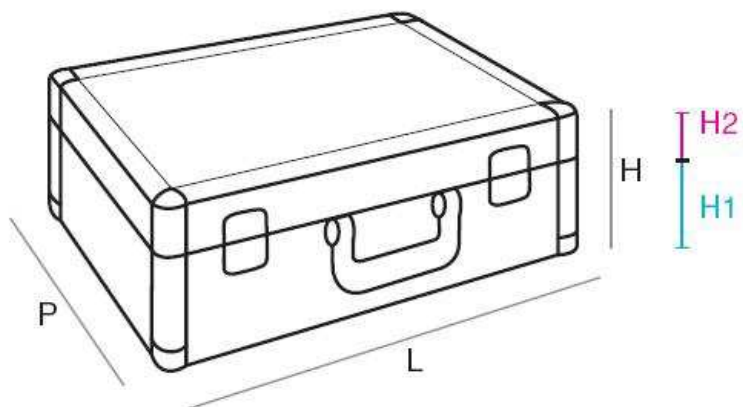

	L	P	H	H1	H2
external	370	245	110	-	-
internal	350	225	-	60	30

EMBOSSED ALUMINIUM

COLORS

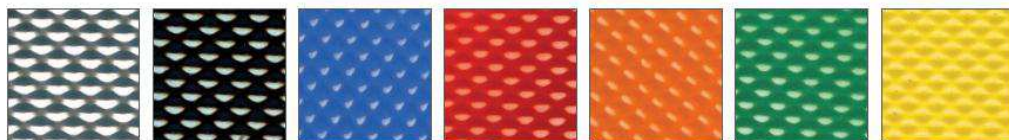

SMOOTH FINISH ALUMINIUM

COLORS



WEIGHT

art. **SWL/80** = 2,5 kg